



GaAs MMIC I/Q DOWNCONVERTER 20 - 28 GHz

Typical Applications

The HMC977LP4E is ideal for:

- Point-to-Point and Point-to-Multi-Point Radios
- Military Radar, EW & ELINT
- Satellite Communications

Features

- Conversion Gain: 14 dB
- Image Rejection: 21 dBc
- 2x LO to RF Isolation: 45 dB
- Noise Figure: 2.5 dB
- Input Third-Order Intercept: 1 dBm
- LO Drive Range: 2 to 6 dBm
- 24 Lead 4 mm x 4 mm SMT Package

Functional Diagram

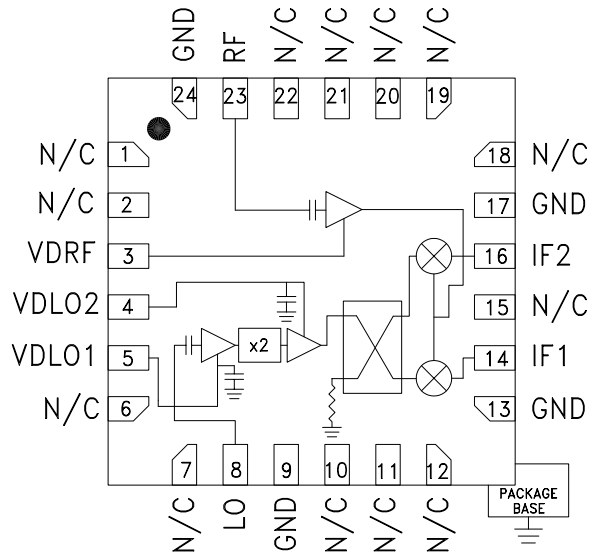

General Description

The HMC977LP4E is a compact GaAs MMIC I/Q downconverter in a leadless RoHS compliant SMT package. This device provides a small signal conversion gain of 14 dB with a noise figure of 2.5 dB and 21 dBc of image rejection. The HMC977LP4E utilizes a low noise amplifier (LNA) followed by an image reject mixer which is driven by an active 2x multiplier. The image reject mixer eliminates the need for a filter following the LNA and removes thermal noise at the image frequency. I and Q mixer outputs are provided and an external 90° hybrid is needed to select the required sideband. The HMC977LP4E is a much smaller alternative to hybrid style image reject mixer downconverter assemblies, and is compatible with surface mount manufacturing techniques.

Electrical Specifications, $T_A = +25^\circ\text{C}$, $IF = 1000\text{ MHz}$, $LO = 6\text{ dBm}$, $V_{dd} = 3.5\text{ Vdc}$, USB [1]

Parameter	Min.	Typ.	Max.	Min.	Typ.	Max.	Units
RF Frequency Range	20		26.5	26.5		28	GHz
LO Frequency Range	8.3		15	11.5		15.7	GHz
IF Frequency Range	DC		3.5	DC		3.5	GHz
LO Drive Range	2		6	2		6	dBm
Conversion Gain (As IRM)	11	14		11	14		dB
Noise Figure		2.5			3.0		dB
Image Rejection		21			20		dBc
Input Power for 1 dB Compression (P1dB)		-8			-7		dBm
2x LO to RF Isolation	35	45		34	39		dB
2x LO to IF Isolation		20			30		dB
Input Third-Order Intercept (IP3)		1			3		dBm
Amplitude Balance [2]		0.3			0.3		dB
Phase Balance [2]		17			12		Degree
Total Supply Current		170	210		170	210	mA

[1] Unless otherwise noted all measurements performed as downconverter with upper sideband selected and external 90° hybrid at the IF ports.

[2] Data taken without external 90° hybrid at the IF ports.



**GaAs MMIC I/Q DOWNCONVERTER
20 - 28 GHz**

Data Taken As IRM With External 90° Hybrid at The IF Ports, IF = 1000 MHz, USB

Conversion Gain vs. RF Frequency Over Temperature, LO Drive = 6 dBm

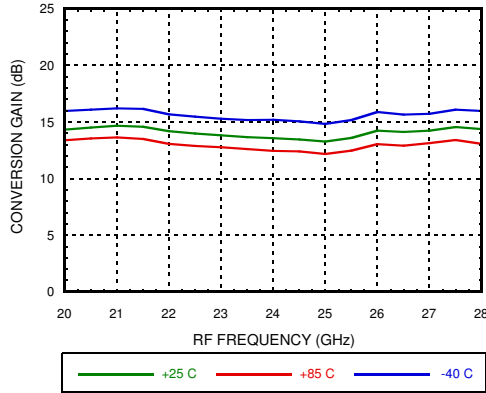

Conversion Gain vs. RF Frequency at Various LO Drives

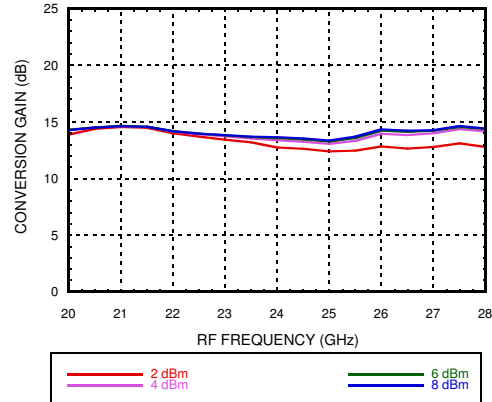
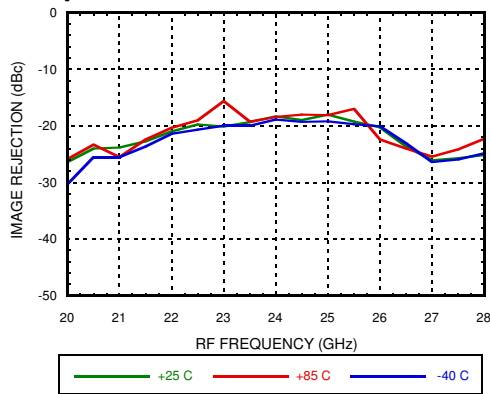
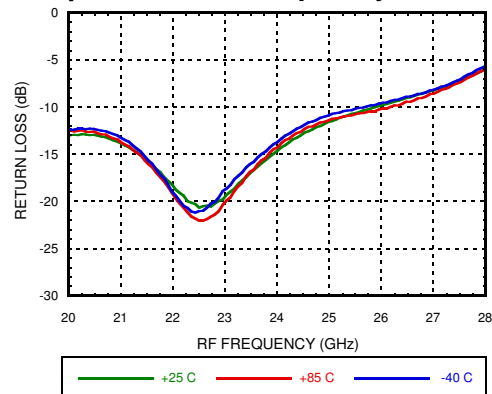

Image Rejection vs. RF Frequency Over Temperature, LO Drive = 6 dBm



RF Return Loss vs. RF Frequency Over Temperature, LO Frequency = 24 GHz



LO Return Loss vs. LO Frequency Over Temperature, LO Drive = 6 dBm

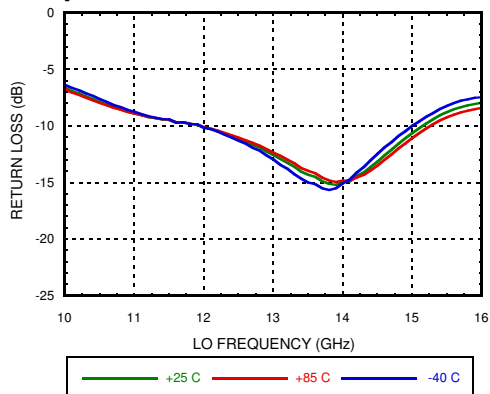

**IF Return Loss vs. IF Frequency [1]
LO Frequency = 24 GHz, LO Drive = 6 dBm**

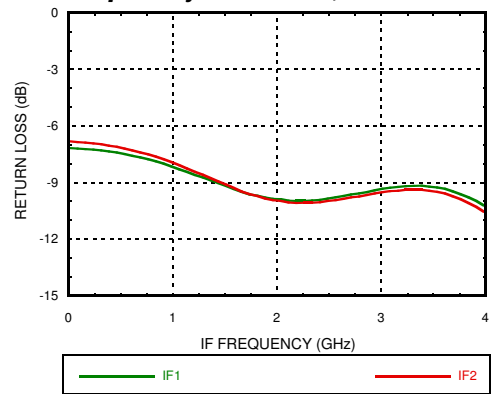

[1] Data taken without external 90° hybrid



GaAs MMIC I/Q DOWNCONVERTER
20 - 28 GHz

Data Taken As IRM With External 90° Hybrid at The IF Ports, IF = 1000 MHz, USB

RF to IF and LO to IF Isolation [1]
vs. RF Frequency, LO Drive = 6 dBm

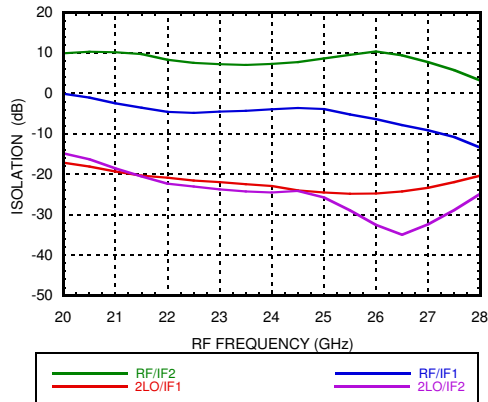

LO to RF Isolation vs. RF Frequency [1]
LO Drive = 6 dBm

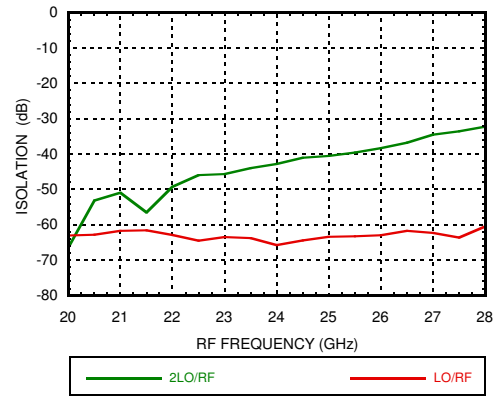

Input P1dB vs. RF Frequency Over
Temperature, LO Drive = 6 dBm

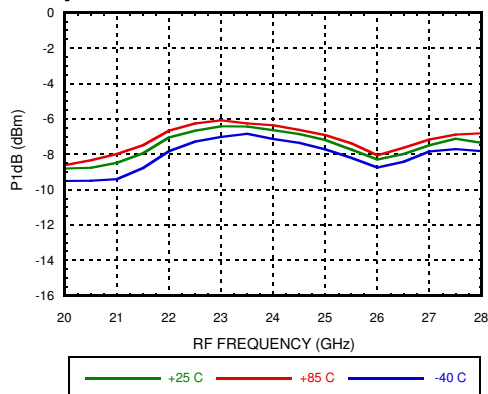

Input IP3 vs. RF Frequency Over
Temperature, LO Drive = 6 dBm

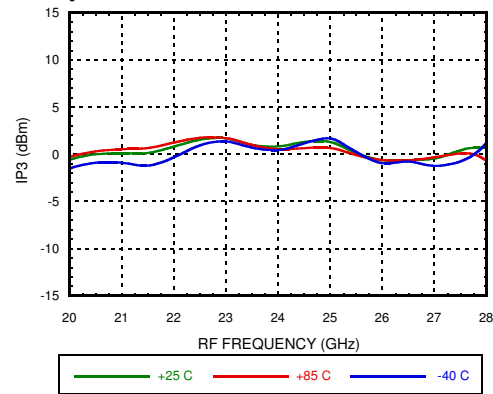

Input IP3 vs. RF Frequency at
Various LO Drives

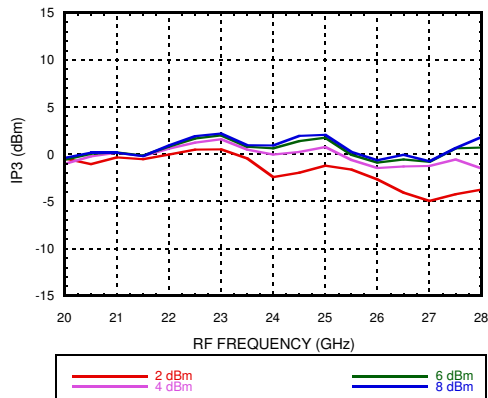

Noise Figure vs. IF Frequency, LO
Frequency = 10 GHz, LO Drive = 6 dBm [1]

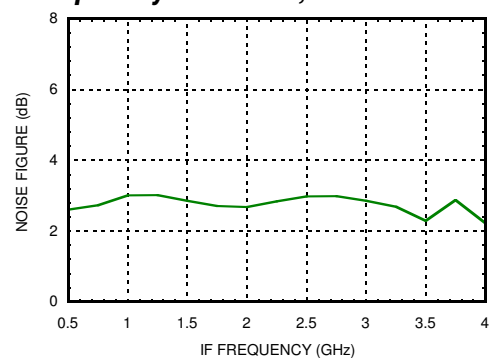

[1] Data taken without external IF 90° hybrid



**GaAs MMIC I/Q DOWNCONVERTER
20 - 28 GHz**

Quadrature Channel Data Taken Without 90° Hybrid at The IF Ports, IF = 1000 MHz, USB

Noise Figure vs. RF Frequency Over Temperature, LO Drive = 6 dBm

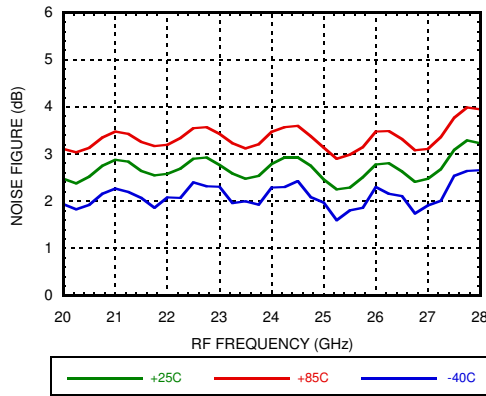

Conversion Gain and Return Loss Over IF Bandwidth

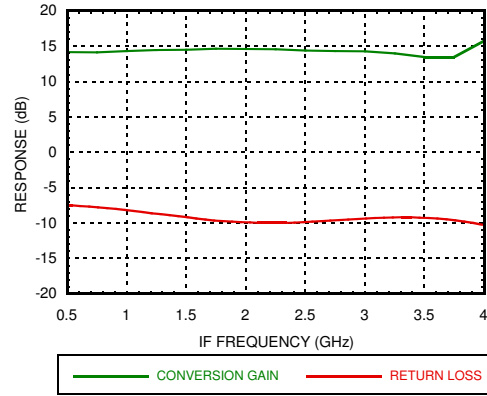

Amplitude Balance vs. RF Frequency at Various LO Drives

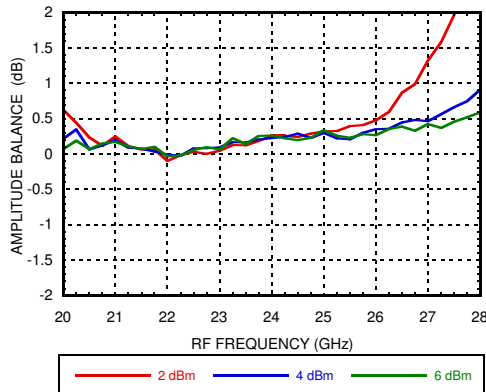

Phase Balance vs. RF Frequency at Various LO Drives

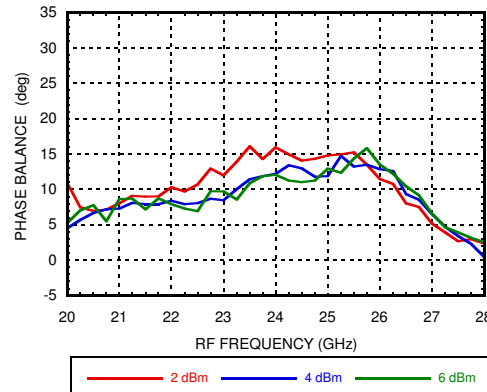

M x N Spurious Outputs, IF = 1000MHz

mRF	nLO				
	0	1	2	3	4
0	x	-22.6	-7.4	-28.8	-37.2
1	-20	-29.3	0	-33	-37.3
2	-72.6	-72.6	-57.6	-43.6	-51.6
3	x	x	-74.6	-74.6	-74.6
4	x	x	x	x	x

RF = 24 GHz, RF Input Power = -20 dBm
LO Frequency = 11.5 GHz, LO Drive = 4 dBm
All values are in dBc below IF power level (RF -2 x LO)
Spur values are (M x RF) - (N x LO)



**GaAs MMIC I/Q DOWNCONVERTER
20 - 28 GHz**

Data Taken As IRM With External 90° Hybrid at The IF Ports, IF = 1000 MHz, LSB

Conversion Gain vs. RF Frequency Over Temperature, LO Drive = 6 dBm

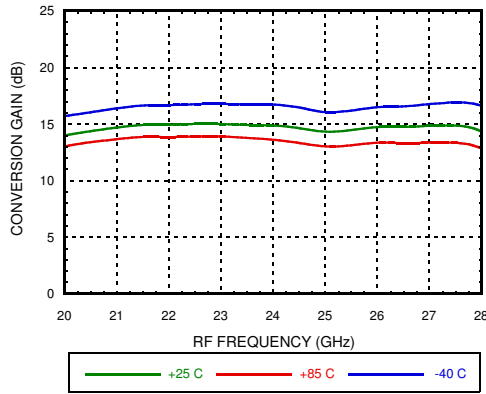

Conversion Gain vs. RF Frequency at Various LO Drives

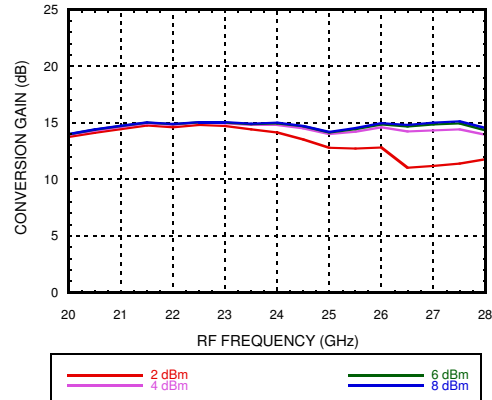
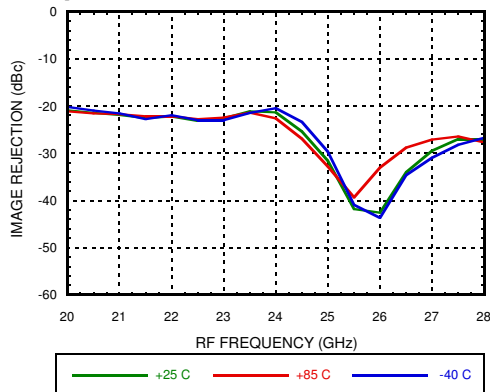
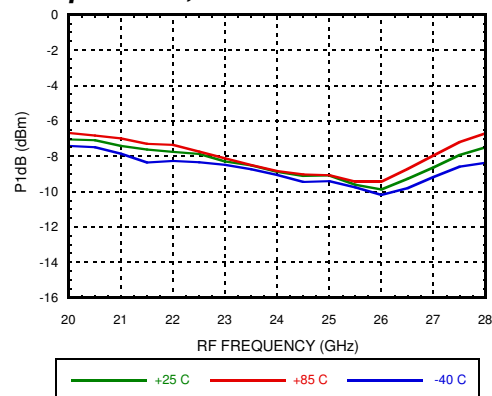

Image Rejection vs. RF Frequency Over Temperature, LO Drive = 6 dBm



Input P1dB vs. RF Frequency Over Temperature, LO Drive = 6 dBm



Input IP3 vs. RF Frequency Over Temperature, LO Drive = 6 dBm

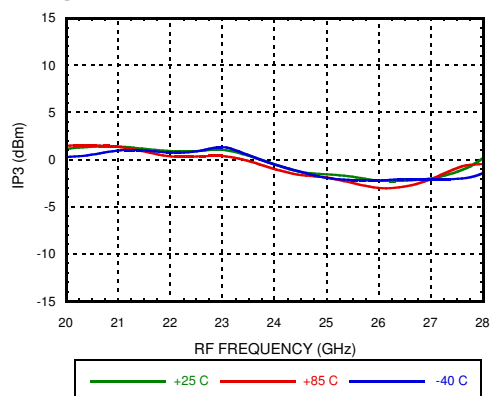

Input IP3 vs. RF Frequency at Various LO Drives

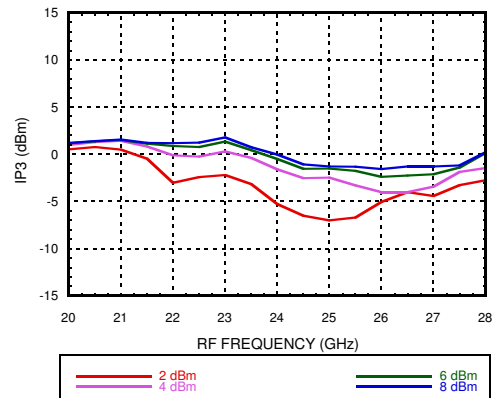



GaAs MMIC I/Q DOWNCONVERTER
20 - 28 GHz

Data Taken As IRM With External 90° Hybrid at The IF Ports, IF = 2000 MHz, USB

Conversion Gain vs. RF Frequency Over Temperature, LO Drive = 6 dBm

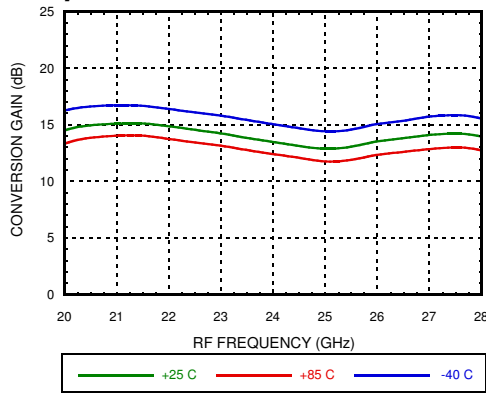

Conversion Gain vs. RF Frequency at Various LO Drives

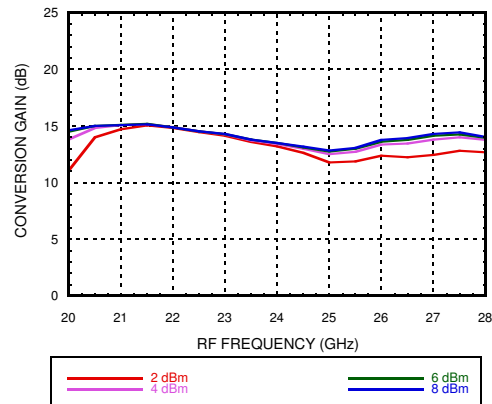
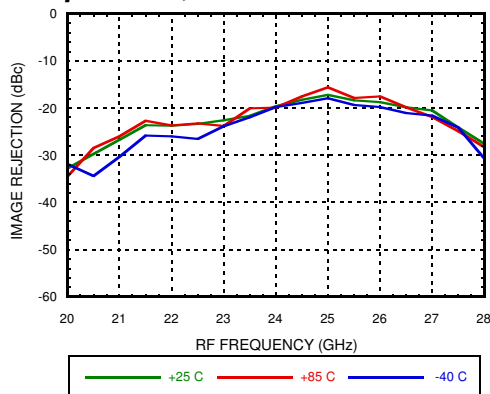
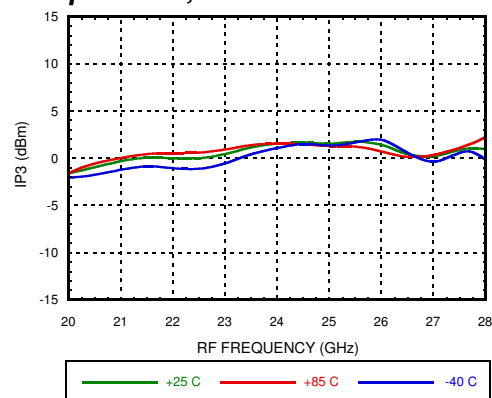

Image Rejection vs. RF Frequency Over Temperature, LO Drive = 6 dBm



Input IP3 vs. RF Frequency Over Temperature, LO Drive = 6 dBm



Input IP3 vs. RF Frequency at Various LO Drives

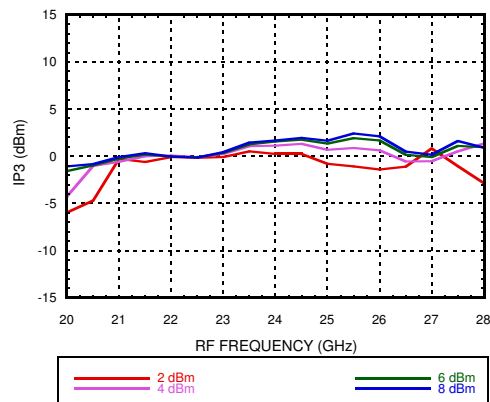



**GaAs MMIC I/Q DOWNCONVERTER
20 - 28 GHz**

Data Taken As IRM With External 90° Hybrid at The IF Ports, IF = 2000 MHz, LSB

Conversion Gain vs. RF Frequency Over Temperature, LO Drive = 6 dBm

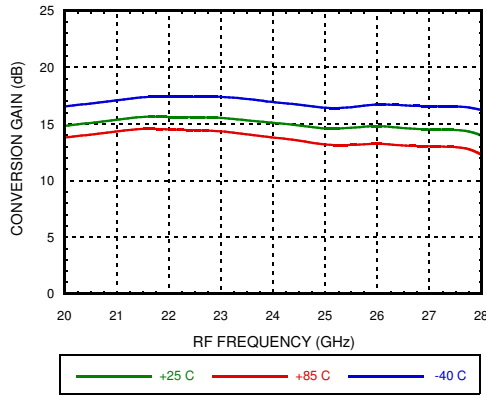

Conversion Gain vs. RF Frequency at Various LO Drives

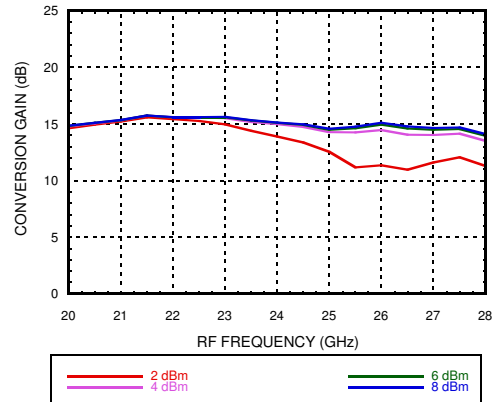
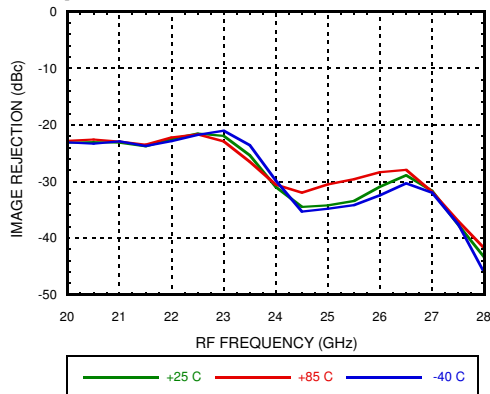
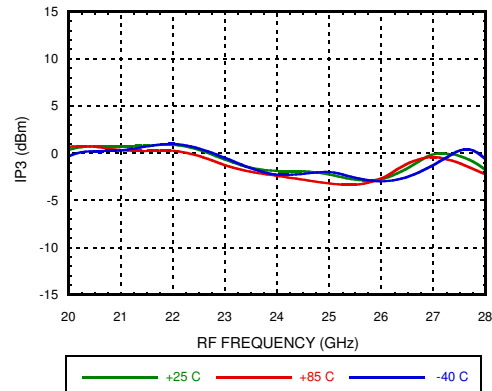

Image Rejection vs. RF Frequency Over Temperature, LO Drive = 6 dBm



Input IP3 vs. RF Frequency Over Temperature, LO Drive = 6 dBm



Input IP3 vs. RF Frequency at Various LO Drives

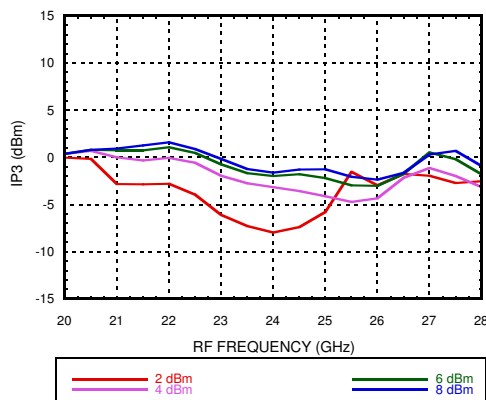



**GaAs MMIC I/Q DOWNCONVERTER
20 - 28 GHz**

Data Taken As IRM With External 90° Hybrid at The IF Ports, IF = 3300 MHz, USB

Conversion Gain vs. RF Frequency Over Temperature, LO Drive = 6 dBm

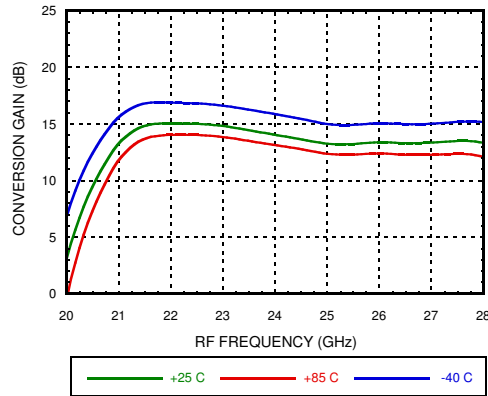

Conversion Gain vs. RF Frequency at Various LO Drives

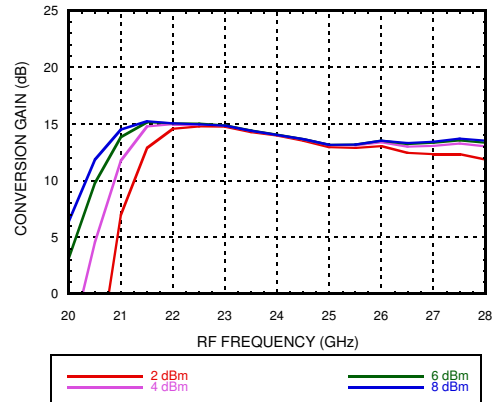
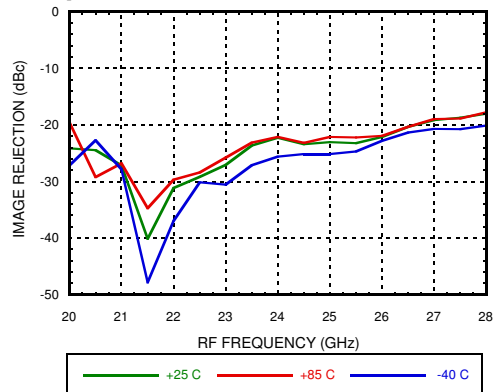
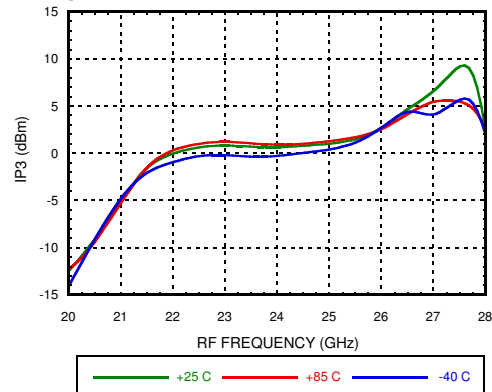

Image Rejection vs. RF Frequency Over Temperature, LO Drive = 6 dBm



Input IP3 vs. RF Frequency Over Temperature, LO Drive = 6 dBm



Input IP3 vs. RF Frequency at Various LO Drives

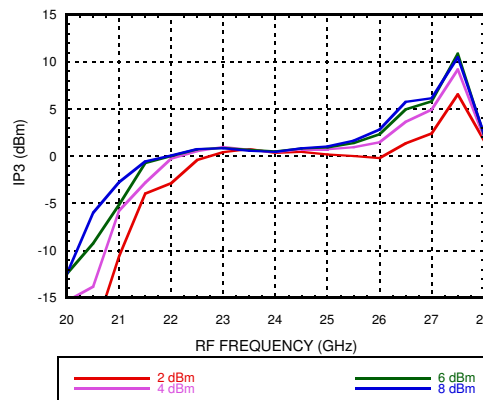



**GaAs MMIC I/Q DOWNCONVERTER
 20 - 28 GHz**

Data Taken As IRM With External 90° Hybrid at The IF Ports, IF = 3300 MHz, LSB

Conversion Gain vs. RF Frequency Over Temperature, LO Drive = 6 dBm

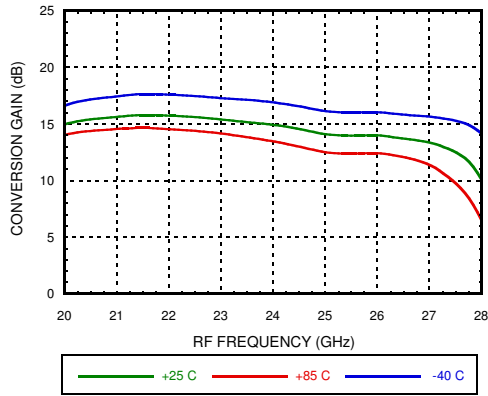

Conversion Gain vs. RF Frequency at Various LO Drives

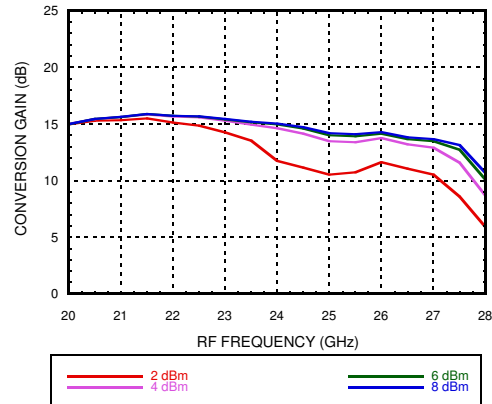
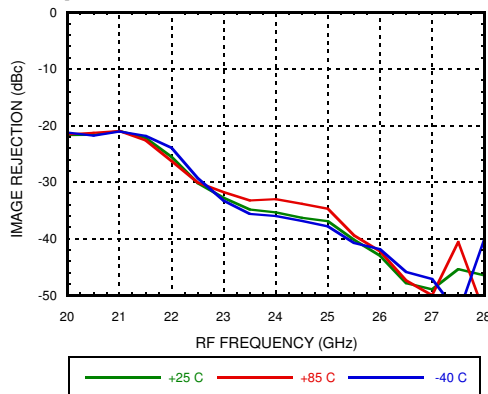
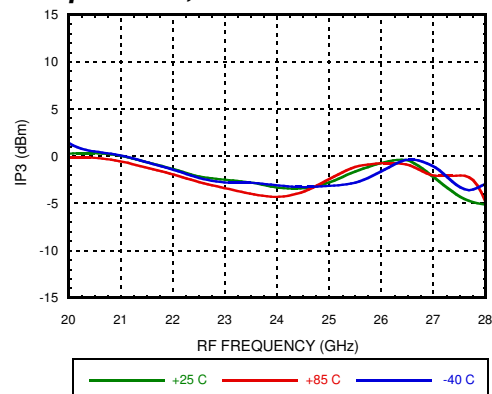

Image Rejection vs. RF Frequency Over Temperature, LO Drive = 6 dBm



Input IP3 vs. RF Frequency Over Temperature, LO Drive = 6 dBm



Input IP3 vs. RF Frequency at Various LO Drives

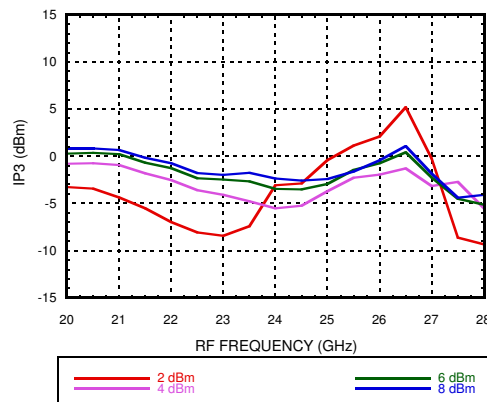



Absolute Maximum Ratings

RF Input Power	2 dBm
LO Drive	10 dBm
Drain Bias (Vdd)	5.0 V
Channel Temperature	175 °C
Continuous Pdiss (T=85°C) (derate 17.7 mW/°C above 85°C)	1.6 W
Thermal Resistance (R _{TH}) (channel to package bottom)	56.3 °C/W
Storage Temperature Range	-65 °C to +150 °C
Operating Temperature Range	-40 °C to +85 °C
ESD Sensitivity (HBM)	Class 1A (250 V)



ELECTROSTATIC SENSITIVE DEVICE
OBSERVE HANDLING PRECAUTIONS

Outline Drawing

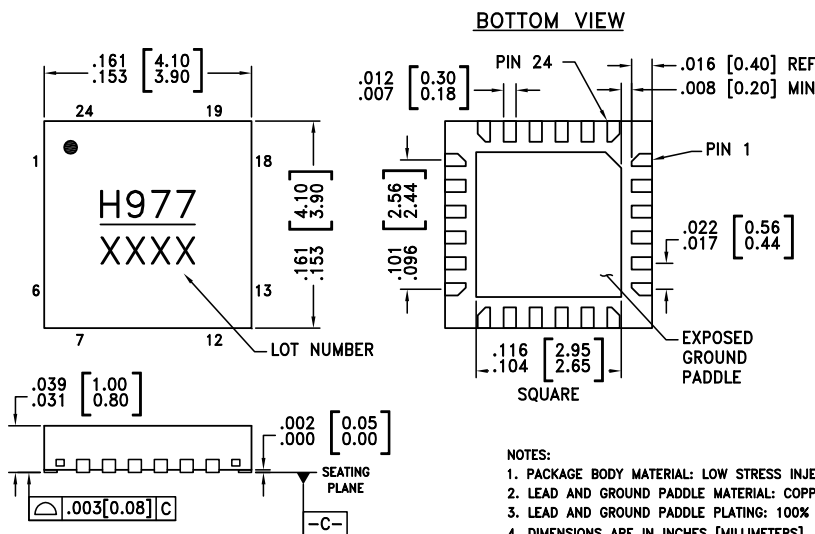

Package Information

Part Number	Package Body Material	Lead Finish	MSL Rating	Package Marking ^[1]
HMC977LP4E	RoHS-Compliant Low Stress Injection Molded Plastic	100% Matte Sn	MSL1 ^[2]	H977 XXXX

[1] 4-Digit lot number XXXX

[2] Max peak reflow temperature of 260 °C



Pin Descriptions

Pin Number	Function	Description	Interface Schematic
1, 2, 6, 7, 10 - 12, 15, 18 - 22	N/C	No Connection. The pins are not connected internally.	
3	VDRF	Power supply for the RF low noise amplifier.	VDRF
4	VDLO2	Power supply for the second stage LO amplifier.	VDLO2
5	VDLO1	Power supply for the first stage LO amplifier.	VDLO1
8	LO	Local Oscillator. This pin is ac-coupled and matched to 50 Ohms.	LO
9, 13, 17, 24	GND	Ground Connect. Connect these pins and the package bottom to RF/dc ground.	GND
16	IF2	Second and First Intermediate Frequency Port. These pins are dc-coupled. For applications not requiring operation to dc, block these pins externally using a series capacitor with a value chosen to pass the necessary IF frequency range. For operation to dc, these pins must not source or sink more than 3 mA of current or device non-functionality or device failure may result.	
14	IF1		
23	RF	Radio Frequency Port. This pin is ac-coupled and matched to 50 Ohms.	RF

Typical Application Circuit

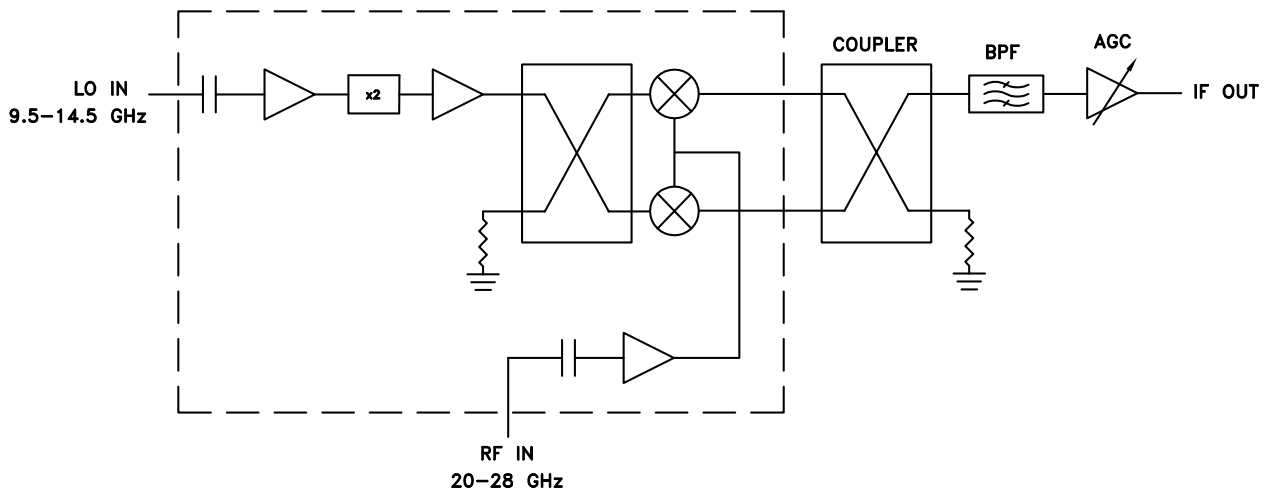

Evaluation PCB

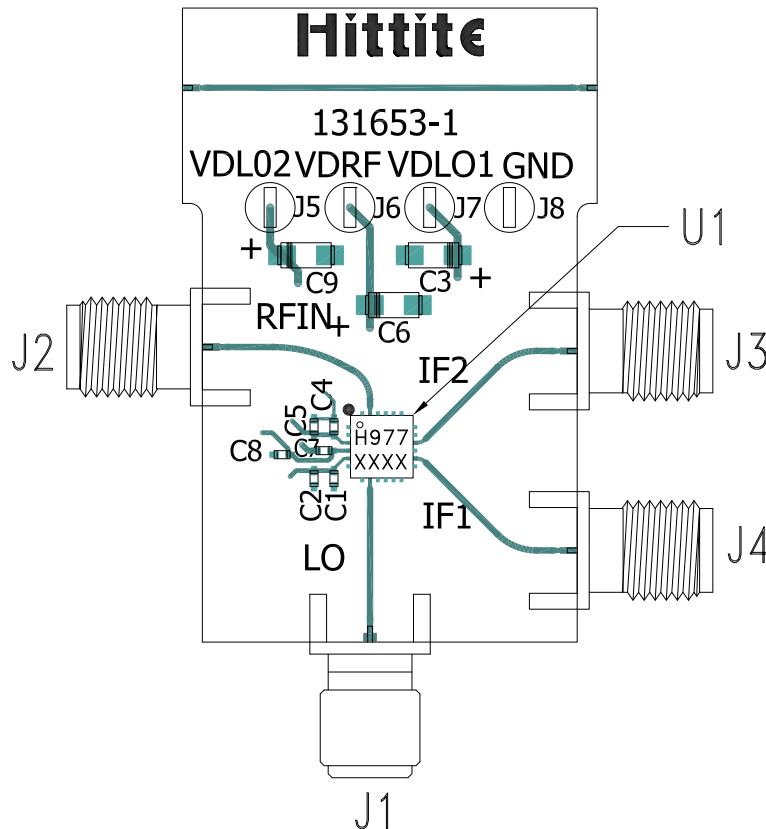

List of Materials for Evaluation PCB 131656 [1]

Item	Description
J1	PCB Mount SMA RF Connector, SRI
J2, J3	PCB Mount K Connector, SRI
J5 - J8	DC Pin
C1, C4, C7	100 pF Capacitor, 0402 Pkg.
C2, C5, C8	10 nF Capacitor, 0402 Pkg.
C3, C6, C9	4.7 μF Capacitor, Case A Pkg.
U1	HMC977LP4E
PCB [2]	161653 Evaluation Board

[1] Reference this number when ordering complete evaluation PCB

[2] Circuit Board Material: Rogers 4350

The circuit board used in the application should use RF circuit design techniques. Signal lines should have 50 Ohm impedance while the package ground leads and exposed paddle should be connected directly to the ground plane similar to that shown. A sufficient number of via holes should be used to connect the top and bottom ground planes. The evaluation circuit board shown is available from Analog Devices upon request.